

Concealed single-lever mixer with diverter - Chrome











IMO

36 120 670



- automatic diverter
- cover plate 150 x 90 mm
- WRAS 2207012

Fits: IMO, MEM, CL.1, CYO

	Chrome	36 120 670-00
	Brushed Platinum	36 120 670-06
	Platinum	36 120 670-08
	Dark Chrome	36 120 670-19
	Brushed Durabrass (23kt Gold)	36 120 670-28
	Matte Black	36 120 670-33
	Brushed Champagne (22kt Gold)	36 120 670-46
	Champagne (22kt Gold)	36 120 670-47
	Brushed Chrome	36 120 670-93
	Brushed Dark Platinum	36 120 670-99

Required miscellaneous



Concealed single-lever mixer - 35 020 970 90
 •max. recess depth 105 mm
 •min. recess depth 80 mm

Recommended miscellaneous



**xGRID Attachment set for
integrating in the dry wall
construction -** 12 340 970 90

Required miscellaneous



**Concealed single-lever mixer with
backflow preventor -** 35 021 970 90
 •max. recess depth 105 mm
 •min. recess depth 80 mm

Required miscellaneous



xGRID Installation track 555 mm - 12 360 970 90

36 120 670

mm [inches]

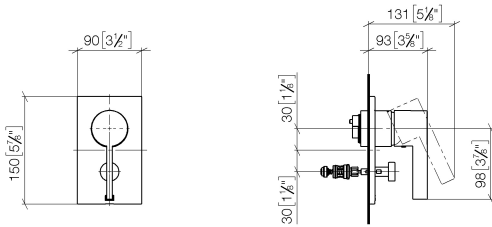

Flow rate chart

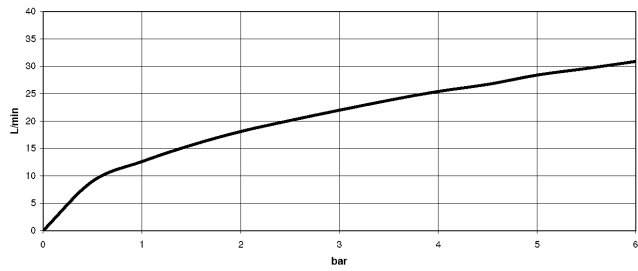

Certificates

LGA_19863.

WRAS_2207012.

36 120 670

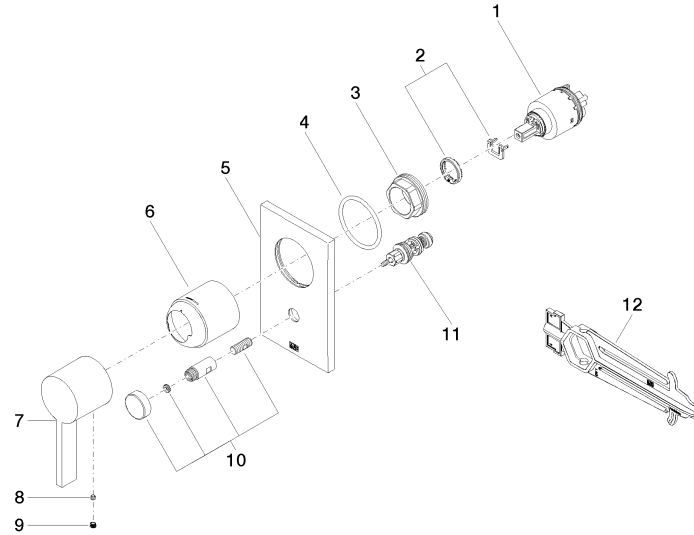

Spare parts list

No.	Item Number	Name	Quantity used	Delivery time
1	90 15 05 038 00 90	cartridge	1	60
2	04 28 10 149 00 90	accessories	1	2
3	09 24 04 448 90	nut	1	2
4	09 14 10 084 90	seal	1	2
5	09 11 02 258-00	plate	1	10
6	09 11 02 260-00	sleeve	1	10
7	09 20 67 007-00	handle	1	10
8	09 31 11 099 90	pin	1	2
9	90 31 20 109 00 90	plug	1	2
10	90 31 09 139 00-00	pull-rod	1	10
11	90 21 34 081 00 90	diverter	1	2
12	90 30 09 064 00 90	key	1	2